

Contents

Page

General warning 9

1. Description of the hoist 11

2. Technical specifications 11

3. Installation 13

4. Operation 13

5. Storage 14

6. Load chain 14

7. Maintenance 14

8. Emergency procedure in case of an incident 14

9. Markings 14

10. Do nots 15



GENERAL WARNING



1. Before installing and using this unit, in a safe and efficient manner, be sure you have read and fully understood the information and instructions given in this manual. A copy of this manual should be made available to every operator. Extra copies of this manual will be supplied on request by Tractel®.
2. Do not use the unit if any of the identification plates mounted on the unit are missing or if any of the information on the plates, in particular the WLL*, is missing or illegible. Identical plates will be supplied by Tractel® on request. The replacement plate must be installed before continuing use of the unit.
3. Each time before using the unit, make sure it is visibly in good condition.
4. The chain must be in good condition to ensure safe, correct operation of the unit. The condition of the chain must be checked each time before use as indicated in the "load chain" section 6. Any unit with a chain showing signs of wear should be removed from use and returned to Tractel® for inspection and repair if necessary.
5. Each time before using the unit, check that the low limit stop is in place.
6. For professional applications, in particular if the unit is to be operated by an employee, make sure that you are in compliance with all safety at work regulations governing installation, maintenance and use of the equipment, and more specifically as concerns the required inspections: verification on commissioning by user, periodic inspections and checks after disassembly or repair.
7. To ensure safe use of the unit, it should be visually inspected and serviced regularly. Depending on the working environment, check for any signs of corrosion or premature wear.
8. Make sure that all persons to whom you have entrusted use of this unit are perfectly familiar with operation of the unit and know all the safety requirements.
9. This unit must only be used in full compliance of all safety regulations and standards applicable at the location of intervention as concerns installation, use, maintenance and inspection of equipment lifting devices.
10. For all professional purposes, the unit must be placed under the responsibility of a person perfectly familiar with the regulations applicable at the intervention location, and having the authority to enforce application of the regulations when the person in charge of the unit is not the operator.
11. Any person using this unit for the first time must check, under risk-free conditions, that he has perfectly understood all the safety requirements and methods for efficient use of the unit before applying any load to this unit. This check can be performed using a test load representing at least 10% of the working load limit (WLL*).
12. The unit must only be installed and set into service under conditions ensuring the installer' safety in compliance with the regulations applicable to its category.
13. Tractel® declines any responsibility for operation

(*): Working Load Limit



of this unit in any mounting configuration other than that described in this manual in section 3 "Installation".

14. The unit must be fastened to an anchoring point and to a structure having the necessary strength to support the maximum load (WLL*) indicated on the unit. If several units are used, the strength of the structure must be compatible with the number of lifting units used and with the maximum utilization load of the units.
15. The unit is designed for manual operation and must never be motorized.
16. When using the lever hoist, the user must ensure that the chain remains constantly tensioned by the load, and more particularly, that the load has not been temporarily snagged by an obstacle when coming down as this could result in rupture of the chain when the load is released from its obstacle.
17. When using the lever hoist, the user must check, at all times, that the chain does not rub against an obstacle.
18. The unit must never be used for lifting people.
19. The unit must never be used for any operations other than those described in this manual. The unit must never be used to handle any loads exceeding the maximum utilization load indicated on the unit. It must never be used in explosive atmospheres.
20. Never park or circulate under a load. Access to the area under the load should be indicated by signs and prohibited.
21. When a load is to be lifted by several units, a technical study must first be carried out by a qualified technician before installation of the units. The installation must then be carried out in compliance with the study, in particular to ensure an even distribution of the load under appropriate conditions. Tractel® declines any responsibility for the consequences resulting from use of a Tractel® device in combination with other lifting devices of another manufacturer.
22. During lifting operations (up or down), the operator must continuously observe the load to prevent any risk of snagging.
23. The load chain forms an integral part of the unit and must not be either disassembled, repaired or modified without Tractel® supervision. Any disassembly or change to the load chain without Tractel® supervision will release Tractel® of any responsibility resulting from unauthorized disassembly or modification of the load chain.
24. The lifting hook forms an integral part of the unit and must not be either disassembled, repaired or modified without Tractel® supervision. Any disassembly or change to the lifting hook without Tractel® supervision will release Tractel® of any responsibility for the consequences resulting from unauthorized disassembly or modification of the lifting hook.
25. Tractel® declines any responsibility for the consequences of any changes made to the unit or removal of parts forming part of the unit.
26. Any disassembly or repair operation carried out on the unit without Tractel® supervision will release Tractel® of its responsibility for any of the resulting consequences, especially as concerns replacement of genuine parts by parts of another manufacturer.
27. Tractel® will only guaranty operation of the unit provided it is equipped with a genuine Tractel® chain in accordance with the specifications indicated in this manual.
28. The unit must be periodically inspected by a Tractel-approved repair agent as indicated in this manual.
29. A servicing handbook must be maintained up to date in accordance with the model given at the end of this manual.
30. When the unit is not being used, it should be stored in a location inaccessible to persons not authorized to use the unit.
31. In the event of definitive removal from service of the unit, all environment protection regulations applicable in the country of use must be observed.
32. The operator shall ensure that they have a firm footing and is otherwise secured before operating the hoist.
33. The operator shall not engage in any activity that will divert their attention while operating the hoist.
34. Before lifting or pulling a load the operator shall be certain that clearance is available to avoid personal injury or property damage.
35. The operator should not leave a loaded hoist unattended at the end of a working shift or for extended periods during the working shift. Where operations are such that this condition cannot be avoided, the operator must be assured that the condition does not create a hazard to people or property.

1. DESCRIPTION OF THE HOIST

The bravo™ hoist is a portable manual handle-actuated hoist for lifting, pulling and tensioning, is normally used on a fixed anchoring point or with suspension trolleys. Information about suspension trolleys can be obtained from Tractel® on request.

Manufactured from high-quality materials, the bravo™ hoist is a robust tool. The hoist has a compact design, is light-weight, portable and easy to install.

 The bravo™ hoist (1) uses the "Double click" system. Based on two unsynchronised clicks, "Double click" guarantees the reliability of lifting, towing and tensioning operations against the risk of veering. "Double click" is specifically recommended for tensioning steel ropes.

The bravo™ hoist is supplied with a standard 1.50 m length of load chain (item 1, fig. 1). The load chain used with the 0.5 t to 3 t models is formed by a single strand with a lifting hook (item 2, fig. 1) at its end. The load chain used with the 6 t model is formed by two lifting

strands and a sheaved lifting hook (item 3, fig. 1).

The free end of the chain is equipped with a low limit stop (item 4, fig. 1).

CAUTION : It is prohibited to fasten a load to the low limit stop.

A disengage device allows for fast easy adjustment of the chain using the limit stop. This operation must only be performed with no load on the hoist.

The bravo™ hoist complies with the requirements of directive 2006/42/CE and is designed to ensure a minimum mechanical strength of $4 \times WLL^*$.

The bravo™ hoist is designed and built to withstand dynamic testing at $1.1 \times WLL^*$ and static testing at $1.5 \times WLL^*$.

Description of a standard delivery: the hoist is delivered in a cardboard package equipped with its lifting chain, along with its user manual and the CE compliance certificate.

(1): except for the 0.25t model

2. TECHNICAL SPECIFICATIONS

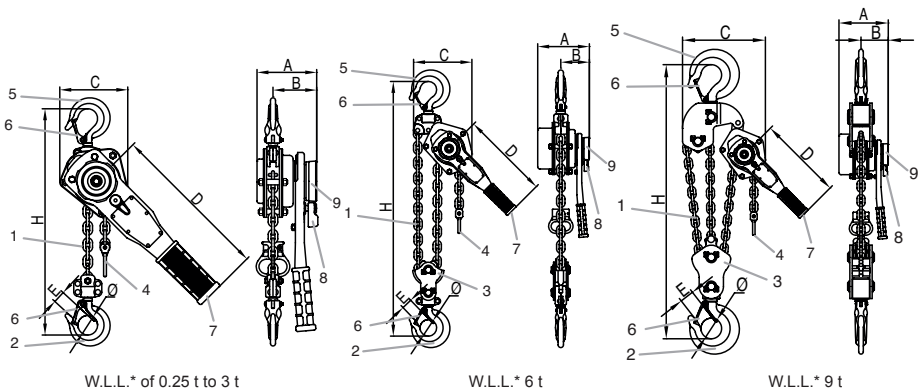

Fig. 1

1: load chain. 2: lifting hook. 3: sheaved lifting hook. 4: low limit stop. 5: suspension hook. 6: safety catch. 7: actuating handle. 8: selector lever. 9: load wheel.

(*) : Working load limit

Fig. 2

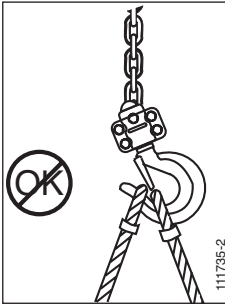

Fig. 3

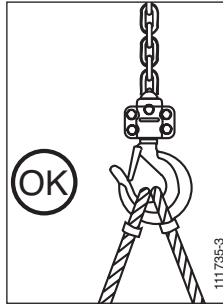

Fig. 4

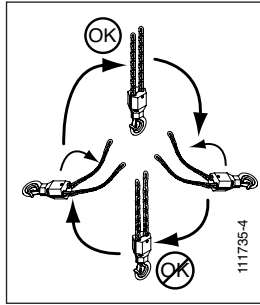

Fig. 5

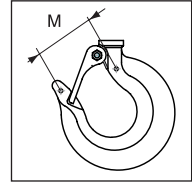
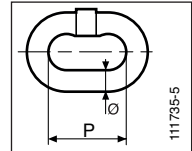

Fig. 6

WLL* (t)	0.25	0.5	0.75	1	1.5	3	6	9	
Standard lifting height** (m)	1.5								
Minimum distance between hook H (mm)	230	305	315	320	365	480	610	800	
Maximum force on handle at WLL* (daN)	28	50	30	37	47	45	47	48	
Number of strands	1						2	3	
Chain dimensions Ø × P (see fig. 5)	4 × 12	5 × 15	6 × 18		7 × 21	10 × 30			
Dimensions (mm)	A	102.5	107	149	149	175	205	205	205
	B	77	78	89	89	101	114	114	114
	C	75	121	125	125	146	191	229	341
	D	157	288	268	268	368	348	348	348
	E	20	22	23	27	29	39	44	58
	Ø	28	35	37	40	45	55	68	85
	M		40.4	43.3	47.8	53.9	68.2	80.5	93.8
Net weight (kg)	2.1	5	7	7.3	11.5	21.4	30.2	56.1	
Additional weight by lifting m (kg)	0.35	0.56	0.8	0.8	1.08	2.23	4.46	6.69	

** : other standard lifting heights for the 0.5t to 9t: 3 m, 4.5 m, 6m.
0.25 t. models: 6 m.

Optionally, the bravo™ hoists of W.L.L.* 0.5t/0.75t/1t/1.5t/3t/6t/9t can be equipped with a dynamic load limiter adjusted between 1.1 and 1.9 × WLL*. The load limiter mechanism is integrated in the lever and is formed by friction disks and a clamping nut by which the limiter is adjusted. This adjustment is performed by Tractel®.

3. INSTALLATION

Before installing the bravo™ hoist make the following checks:

1. Check that the hoist is in good condition.
2. Check that the correct hoist capacity is to be used.
3. Check that the hooks and safety latches are in good condition.
4. Check that the low limit stop is in place.
5. When the hoist uses a multiple strand chain, make sure that the strands are not tangled or twisted.
6. Check that the load chain is correctly fitted.
7. Check that the anchor point is sufficient to take the intended load.

After successfully completing the preliminary checks, install the bravo™ hoist on its anchoring point and perform the following checks:

1. Check that the bravo™ hoist is properly suspended by its suspension hook (item 5, fig. 1) and that the hook safety catch (item 6, fig. 1) is properly closed (see figs 2 and 3).
2. Check that the load chain has not been subjected to any torsion when setting up, in particular for the two-strand version (see fig. 4).
3. Without load, check that the up and down functions operate correctly.
4. When using the hoist with a push suspension trolley, without load, check that the trolley moves freely. If using a geared suspension trolley, without load, check the direction of movement by pulling on the trolley hand chain. The movement should be carried out on a strictly horizontal plane.

After successfully completing these checks, place the load in position and ensure:

1. the anchoring accessory of the load sits fully in the hook and does not prevent the catch from closing correctly (see figs. 2 and 3).
2. the load on the hoist is free to align itself with the machine's anchoring point.

4. OPERATION

4.1. Operating principle

The bravo™ hoist is operated by means of an actuating handle (item 7, fig. 1) which is moved back and forth by the operator to lift or lower a load, pull a load, or apply tensioning.

4.2. Installing the lifting hook on the load rigging point

If installation of the lifting hook requires adjustment of the chain length, proceed as follows:

1. Make sure that there is no load on the chain.
2. Set the movement selector lever (item 8, fig. 1) to the neutral position "0".
3. With no load on the machine, turn the load wheel (item 9, fig. 1) anti-clockwise to open the brake; the chain is released.
4. If it is not possible to turn the wheel, put the selector lever in the down position and pull the hook holding chain downwards. Place the selector lever back in "neutral" and pull on the released chain using the lower limit stop.
5. Secure the lifting hook to the load (or to a fixed point), or to the point where tension will be applied. Apply a slight tension to the chain by pulling on the chain using the low limit stop.
6. Turn the load wheel clockwise; the brake is closed. The chain is engaged in the hoist.

4.3. Maneuvering the hoist

1. To lift, pull or tension: put the selector lever to position ↑ and operate the lever handle back and forth.

For a hoist equipped with the load limiter option: if the load is greater than $1.5 \times WLL^*$ (average), the operator's action on the lever will not have any effect on the load and, under these conditions, it will be impossible to lift the load.

Important: Repeated triggering of the limiter can result in wear causing a decrease in the load limitation threshold. In this case, the unit must be checked by Tractel®.

2. To lower or slacken: put the selector lever to position ↓ and operate the lever handle back and forth.

GB

4.4. Important additional instructions

1. When taking the bravo™ hoist out of service ensure that there is no load applied and that the load chain is slack enough to enable the bottom hook to be removed from the load.
2. The selector lever must not be left in the neutral position "0" when a load is suspended or the hoist is tensioned. Make sure that the selector lever is in the desired position and is not located between two positions.
3. Do not attempt to operate the load wheel during any operation or when a load is suspended on the hoist.
4. It is not recommended to operate the lever handle at excessive speed as this will lead to an uneven movement of the load. It is recommended to operate the lever handle in a steady movement to prevent any unnecessary jerking of the load.

5. STORAGE

It is recommended that the hoist be stored hanging so that the load chain does not become tangled. Store the hoist in a dry and weather-proof area. Before storage clean the load chain with a brush and lubricate with machine oil.

6. LOAD CHAIN

The good condition of the load chain is a guarantee of safety and at the same time the good operation of the hoist. It is therefore necessary to constantly be aware of the condition of the load chain and to clean and lubricate with machine oil at regular intervals.

The load chain must be examined daily by a competent person when the hoist is being used (see technical data sheet T2208).

Do not expose the load chain to excessive temperatures, abrasive materials or chemicals. Protect the chain against all possible damage such as from welding arcs.

7. MAINTENANCE

Periodically, or at least once every year, and in accordance with the safety regulations applicable in the country of use, the hoist must be inspected and tested with load by qualified maintenance personnel.

Periodically, and especially after an intensive use, lubricate the mechanical parts. Never let brake discs receive some lubricant. They have to be kept clean and dry.

Regularly check the condition of the hooks. If the deformation between the hook opening indicators is greater than 2 mm, (Fig. 6, distance "M" given in table of § 2 Technical specifications), the unit must be considered as damaged and removed from service.

If any damage is observed, return the bravo™ hoist to a Tractel®-approved repair workshop.

8. EMERGENCY PROCEDURE IN CASE OF AN INCIDENT

In the event of a blocked chain or any other malfunction of the unit, immediately stop the maneuver without attempting any further actions and call in the necessary qualified personnel to remove the load and intervene on the hoist.

Immediately set up a safety perimeter around the hoist and directly under the load to prevent access by any unauthorized persons. Return the hoist to a Tractel®-approved repair agent.

9. MARKINGS

9.1. Standard marking

A nameplate is riveted to each bravo™ hoist (fig. 7), containing the following information:

- item 1: hoist designation,
- item 2: Working Load Limit (WLL*) in t,
- item 3: dimensions of load chain,
- item 4: CE marking,
- item 5: manufacturing date YYMM (YY: last two figures of the year of manufacture MM: month of manufacture),
- item 6: symbol indicating that you must read this manual before using the hoist,
- item 7: manufacturer's address and contact data:
Tractel SAS France
RD 619 Saint-Hilaire-sous-Romilly
BP38 – F-10102 FRANCE
- item 8: Serial No.,
- item 9: direction of movement of lifting hook.
- item 10 : The bravo™ hoist uses the "Double click" system, see Section 1.

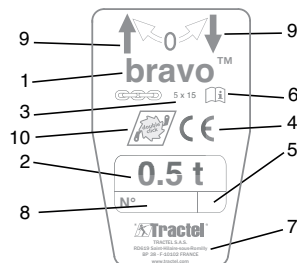

Fig. 7

Chain lubrication label (fig. 8) fastened on each unit.



Fig. 8

9.2. Optional marking

Label (fig. 9) fastened on each unit equipped with load limiter option.



Fig. 9

10. DO NOTS

Do not:

- Use the hoist if it has not been inspected for more than 1 year.
- Use the unit if its chain is bent, worn or severely corroded.
- Use the hoist with any chain other than a genuine Tractel® chain.
- Use the hoist with an extension on the actuating handle.
- Use the hoist if the load chain is not correctly positioned in the load sheave and in the pulley block.
- Make any changes to the hoist.
- Use any parts or components other than genuine Tractel® parts and components.
- Use a hoist which is not in good condition.
- Use the hoist without first having performed the checks described in this manual.
- Secure the hoist to a support which is not sufficiently strong.
- Secure the hoist by any means other than its suspension hook.
- Clamp the suspension hook.
- Attempt to lift fixed or blocked loads.
- Set the selector lever to the "0" position when the chain is tensioned.
- Use a high pressure cleaner or chemical products (acids, chlorinated products) to clean the hoist.
- Use the hoist at loads exceeding its working load limit (WLL*).
- Operate the lever in any way other than manually.
- Use the hoist if the markings are not legible.

- Use the hoist in an explosive environment (device not compliant with ATEX directive) or in a highly corrosive environment.
- Use the hoist at temperatures of less than -10°C or greater than +50°C.
- Use the hoist to lift a load when the wind speed is greater than 50 km/h.
- Use the hoist, even occasionally, to lift or move persons.
- Use the hoist, even occasionally, to lift or move persons.
- Use the hoist for operations other than those for which it is intended or using setup diagrams other than those described in this manual.
- Use the hoist under lighting conditions which are not sufficient to clearly observe the load along its entire path.
- Use the hoist if any of the safety systems are damaged or not operating correctly.
- Use the hoist if a hook is bent or shows any abnormal signs of wear.
- Use the load chain as an electrical ground or electrical conductor.
- Apply the load to the hook end.
- To force the lever when the lower end stop blocks the hoist.
- Force the lever in the load lifting direction when the lifting hook is against the unit
- Pull sideways on loads to be lifted.
- Use the bravo™ load chain as a sling.
- Use the tralift™ hoist as a sling.
- Raise or lower a load without having a clear view of the entire path.
- Allow the load to swing under the hoist.
- Stand under or move around under the load.
- Allow the bravo™ load chain to rub against an obstacle.
- Actuate the load wheel during a maneuver or when the chain is tensioned.
- Fasten a load to the low limit stop.
- Strike the actuating handle.
- Intervene on the hoist without first having removed the load from the hoist.
- To intervene on the load limiter adjustment.

GB