

ET / HT / CE - EN 361 - EN 358

Operating and maintenance instructions

English

GB

GB

Fall arrest harnesses and work positioning belts



CE



	d	e	f	g	h	l	u	o	t
ET10	-	-	-	1	-	-	-	-	-
ET11	-	2	-	1	-	-	-	-	-
HT10	-	-	-	1	-	-	-	-	-
HT11	-	-	-	1	1	-	-	-	-
HT21	2	-	1	1	1	-	-	-	*
HT22	2	-	1	1	1	-	-	-	*
HT31	2	-	-	1	1	-	-	-	*
HT33	2	-	-	1	1	2	-	4	*
HT34	2	2	1	1	1	2	-	4	*
HT42	2	2	-	1	1	-	-	-	*
HT43	2	2	1	1	1	-	-	-	*
HT44	2	2	-	1	1	-	-	-	*
HT45	2	-	1	1	1	-	-	-	*
HT46	2	2	1	1	1	-	-	-	*
HT47	2	-	-	1	1	-	-	-	*
HT120	2	2	1	1	1	-	-	-	*
HT Ladytrac	-	-	-	1	-	-	-	-	*
HT Ladytrac B	-	-	-	1	-	2	-	-	*
CE01	-	-	-	-	-	2	-	4	-
CE02	-	-	-	-	-	2	-	4	-
CE03	-	-	-	-	-	2	-	-	-
CE04	-	-	-	-	-	2	1	4	-
CE06	-	-	-	-	-	2	-	4	-
CE07	-	-	-	-	-	2	1	4	-
CE08	-	-	-	-	-	2	1	4	-

- : Sans objet
* : Option

- : Not applicable
* : Option

- : Nicht zutreffend
* : Zusatzausstattung

- : Niet van toepassing
* : Optie

- : Sin objeto
* : Opción

- : Senza oggetto
* : Opzione

- : Χωρίς αντικείμενο
* : Προαιρετικά

- : Gjelder ikke
* : Opsjon

- : Ej tillämpligt
* : Tillval

- : Ei koske
* : Valinnainen

- : Ikke relevant
* : Tilvalg

- : Nie dotyczy
* : Opcja

- : Не применяется
* : Дополнительная опция

1

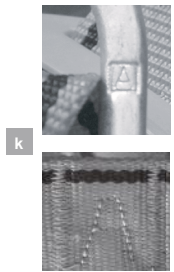
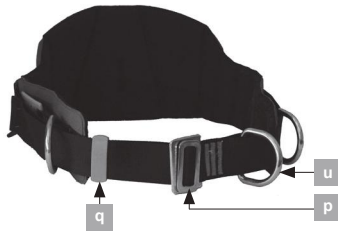
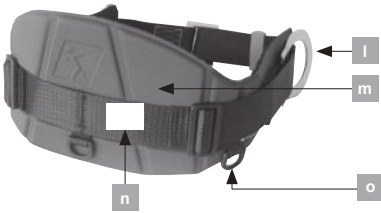
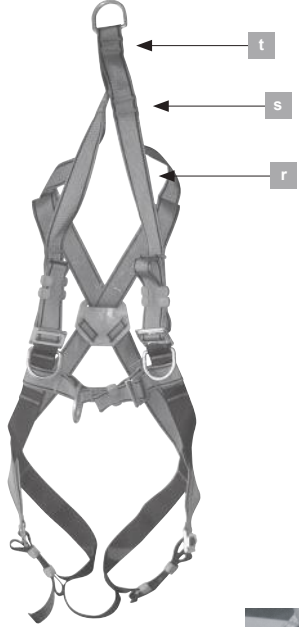
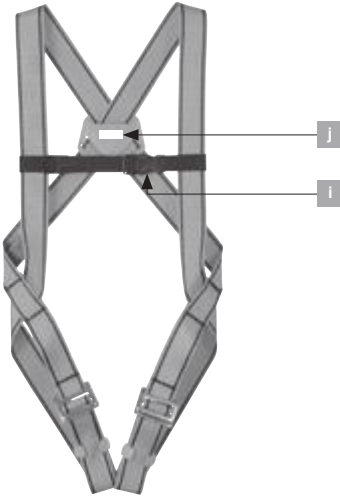
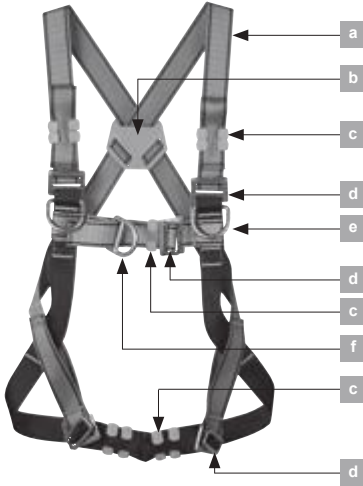

2

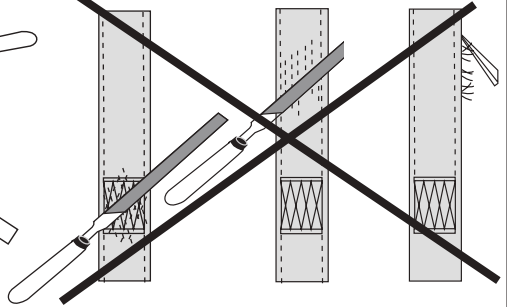
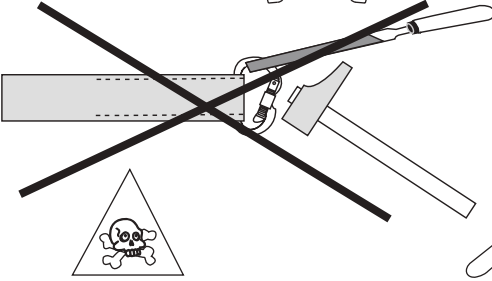
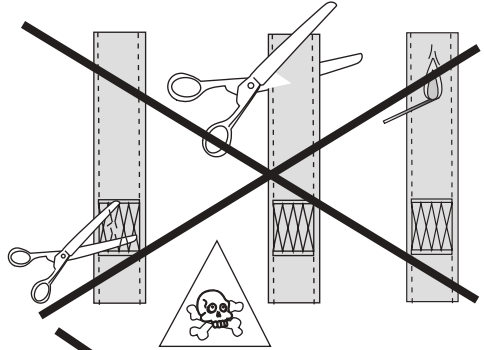
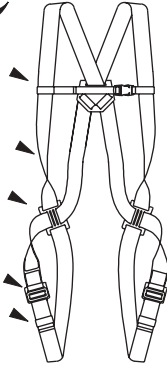

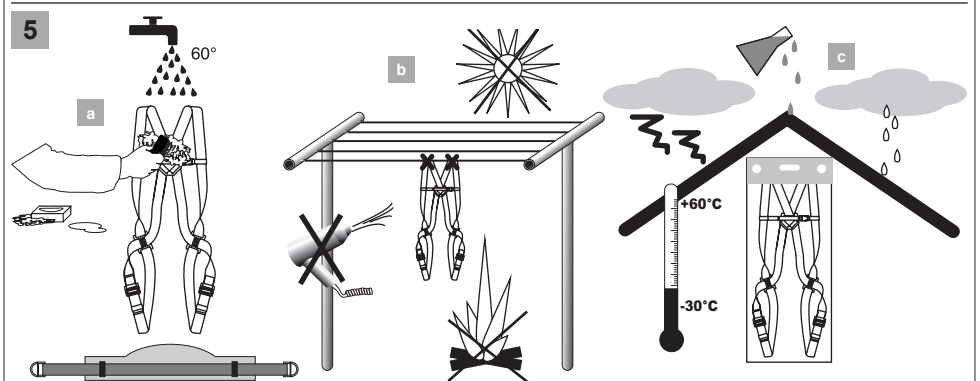
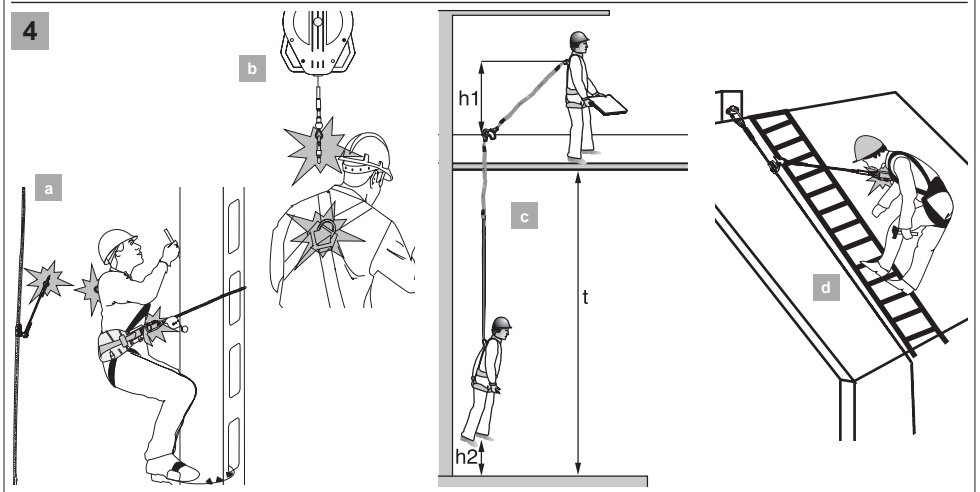
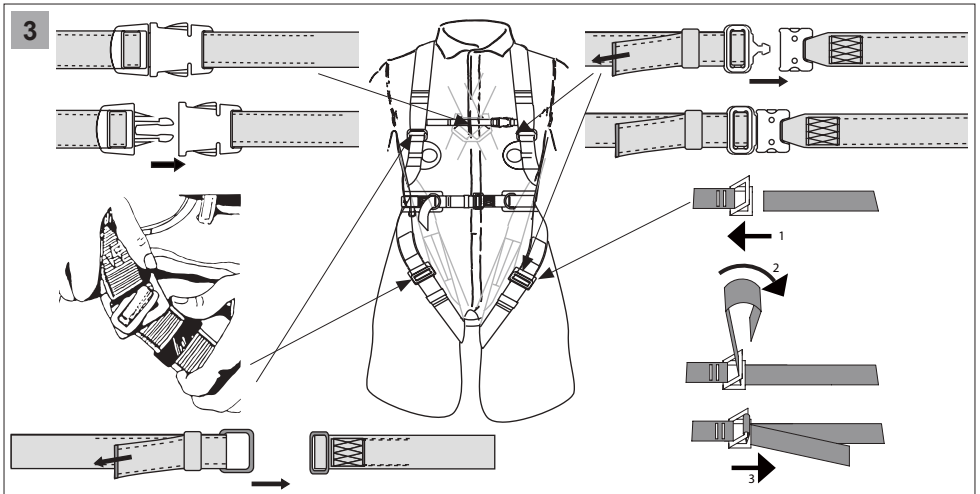

1. Warning

1. HT/ET harnesses are a component of the fall-arrest system, HT R harnesses are a component of the fall-arrest system that can be used for rescue operations. This equipment complies with standards EN 361/EN1497 which can be coupled with CE belts complying with standard EN 358. These two types of equipment can only be used by one trained and/capable person, or by an operator under the direct supervision of such a person.
2. Before using an HT/ET harness, and to ensure safe, efficient use of the harness, it is essential that the user be properly trained in the use of the equipment and has read and understood the information given in the manual supplied by Tractel® SAS. This manual should be available to users at all times. Additional copies of the manual can be supplied on request. The user should perform an initial suspension test in a safe location to ensure that the harness is properly adjusted and provides an acceptable level of comfort for the planned application.
3. Before use, it is essential that users are trained in the use of this safety device. Check the state of associated equipment and make sure that there is adequate room for movement.
4. If a harness is not in apparent good condition, it must be verified by Tractel® SAS, or by an approved and competent technician, who must authorise the continued use of the system in writing. It is recommended to make a visual inspection prior to each use.
5. Any modification or attachment made to the equipment cannot be done without prior written approval from Tractel® SAS. The equipment must be transported and stored in its original packaging.
6. Any harnesses that have not been subject to periodical inspection within the last 12 months, cannot be used. They can only be used again after a new periodical inspection carried out by an approved and competent technician who can offer written permission for use. Failing this inspection and approval, the harness will be dismantled and destroyed. If it has arrested a fall, it must be dismantled and destroyed.
7. The maximum working load is 150 kg for HT/ET harnesses and the same for the CE work station support belts.
8. If the weight of the user increased by the weight of their equipment and tools is between 100 kg and 150 kg, you must ensure that the total weight (user, equipment + tools) does not exceed the maximum load of each of the components of the fall-arrest system.
9. This device is suitable for use on an open air site and for a temperature range of -30° C to +60° C. Avoid any contact with sharp edges, rough surfaces and chemical substances.
10. Important: If you are responsible for assigning this equipment to an employee or similar person, ensure that you comply with the applicable health and safety at work regulations.
11. The operator must be 100% fit and mentally sound when using this equipment. If in doubt, consult a doctor or an occupational physician. Prohibited for pregnant women.
12. The equipment should not be used beyond its limits or in any other situation than that provided for (cf. '4 - Functions and Description').
13. We recommend that the harness be attributed to each operator personally, especially in the case of a salaried workforce.

14. Before using a NF EN 363 fall arrester device, the user must ensure that each of the components is in good working order: security system, locking system. During installation, no damage should be made to any of the security functions.
15. In a fall-arrest system, it is essential to check the free space under the operator at the workplace before each use, so that in the event of a fall there is no risk of hitting the ground or an obstacle in the path of the fall.

Figure 4.c, page 5.

- ▶ **h1** must be between 0 m and 1.5 m.
- ▶ **h2** must be at least 1 m.
- ▶ **t** is the minimum air space under the operator's feet.

This can vary according to the type of fall-arrest device connected to the harness.

- For a blocfor™, t = 3 m minimum.
 - For a stopfor™, t = 4 m minimum.
 - For a lanyard with energy absorber, t = 6 m minimum.
 - For a stopcable™ (EN 353-1), t = 2 m minimum.
 - For a stopcable™ (EN 353-2), t = 4 m minimum.
16. The harness must be withdrawn from storage and maintained in accordance with the instructions given in the manual. Failure to observe the instructions given in the maintenance and storage section can have a very negative impact on the service life of the harness.
 17. It is essential for the safety of the operator that the device or anchoring point is correctly positioned and that work is carried out so as to minimise the risk of falls from height.
 18. For the safety of the operator, if the product is sold outside the initial country of destination, retailers must provide: An instructions manual and a maintenance manual for periodic inspection and repair purposes, written in the language of the country in which the equipment is to be used.



NOTE

For all special applications, contact the TRACTEL® network

2. Definitions and symbols

2.1 Definitions

"User": Person or department responsible for the management and safety of use of the product described in the manual.

"Technician": Qualified person in charge of the maintenance operations described in, and authorised by the user manual, who is competent and familiar with the product.

"Operator": Operational personnel involved in the use of the product as it is intended to be used.

"PPE": Personal protective equipment against falls from height.

"Connector": Connection element between components of a fall-arrest system. This is EN 362 compliant.

"Fall arrest harness": Body harness designed to arrest falls. It consists of straps and buckles. It features fall-arrest attachment points marked with an **A** if they can be used alone, or marked with **A/2** if they are to be used in combination with another **A/2** point. This is EN 361 Standard compliant.

"Maximum operating load": Maximum weight of the fully dressed user, equipped with their PPE, work clothes, tools and components required for the job in hand.

"Fall-arrest system": Equipment consisting of following components:

- Fall-arrest harness.
- Self Retracting Lifeline, energy absorber or mobile fall arrester on rigid anchor point, or fall arrester on flexible anchor.
- Anchoring.
- Linking component.

"Fall-arrest system component": Generic term defining one of the following:

- Fall-arrest harness.
- Self Retracting Lifeline, energy absorber or mobile fall arrester on rigid anchor point or fall arrester on flexible anchor.
- Anchoring.
- Linking component.

2.2. Pictograms



DANGER: Placed at the beginning of the line, refers to instructions to avoid injury to persons, including death, serious or minor injuries, and damage to the environment.



IMPORTANT: Placed at the beginning of the line, refers to instructions for avoiding a failure or damage to equipment, but do not directly endangering the life or health of the operator or that of others, and/or not likely to cause environmental damage.



NOTE: Placed at the beginning of the line, refers to instructions to ensure the effectiveness and convenience of installation, use or maintenance operations.

3. Operation

Every time before use, check:

- Visually check the condition of the harness, straps, stitching and loops. The strap and stitch threads must not show any signs of abrasion, fraying, burns or cuts. The adjustment devices and loops must not show any signs of corrosion or deformation and should operate correctly. If you have any doubt, immediately remove the product from circulation.
- Check the state of the harness and connector attachments.
- Check the complete fall arrester system.

4. Functions and description



IMPORTANT: The HT/ET harness are intended to create an anchorage point on the operator to form a fall-arrest system to protect him against a fall when performing work at heights. A fall-arrest harness is the only device which can be worn on a body in a fall-arrest system.

CE belts are systems to support the operator at the work station.



DANGER: CE belts must not be used as protection from falls from height.

The maximum load for HT/ET harness use and CE work station support belts is 150 kg.

By reference to their respective manuals, you must make sure before use that all the components of the fall-arrest system are compatible with this load.

If this is not the case, the maximum load will be that of the fall-arrest system component with the lowest maximum load.

Depending on the type of harness, there are several possible uses :

- Harness with back anchorage point: fall-arrest safety for working at heights,
- Harness with back and chest anchorage point: same harness with back anchorage point + work positioning, safety when climbing ladder, etc,
- Harness with belt anchorage point: fall-arrest safety according to type and anchorage points available, belt anchorage point for work positioning. In a work station support system, the lanyard must be kept taut and free movement must be limited to a maximum of 0.6 m.
- The HT R harnesses are similar to the HT harnesses, but equipped with an additional stitched rescue lanyard on the shoulder straps. This lanyard enables the rescuer to efficiently evacuate the injured person. The harnesses are fitted with a label located near the rescue lanyard D-ring used for attachment. The label specifies that the lanyard must only be used for rescue operations.
- The Ladytrac™ harnesses are primarily intended for women. Their special, patented design allows them to perfectly adapt to a woman's body. The harnesses are equipped with a vest for easy fitting.
- The HT120 harness has a thoracic anchor point especially designed and positioned to connect to a rail-mounted fall arrester for ladders. The special feature of the thoracic anchor is its ability to move, during a fall, by tearing a seam. The principle is patented. It is specifically positioned for this application, and will not hinder the operator during ascent or descent.

See table of attachment points on page 2.



DANGER

Do not use belt lateral anchor points as anchors for the fall arrester; these must only be used for work positioning purposes (EN 358) in combination with a work positioning lanyard (EN 358), nor the anchor point for the lifesaving lanyard (EN 1497) used for evacuation only.

Figure 4 (a, c, d), page 5.

Do not use the harnesses for any purpose other than protection against fall from heights. Use of the harness for leisure or sport activities is prohibited.

5. Usage constraints description

It is strictly forbidden:

- To install or use an HT/ET harness or CE work station support belt without being authorised, trained and certified as competent or failing that, without being under the supervision of an authorised person, trained and certified as competent.
- To use an HT/ET harness or work station support belt if its CE marking is not readable.
- To install or use an HT/ET harness or CE work station support belt if all necessary checks have not been performed.
- To install or use an HT/ET harness or CE work station support belt that has not been subject to a periodical inspection within the last 12 months by a technician who has authorised its return to use in writing.

- To use an HT/ET harness for any other application than protecting people from falling from heights.
- To use a CE work station support belt for any other application than holding the operator in place at the work station.
- To anchor an HT/ET harness by any other means than the anchor point marked **A** or **A/2**.
- To use an HT/ET harness or CE work station support belt in a manner that contradicts the information defined in "13. Life cycle".
- To use an HT/ET harness or CE work station support belt for a person whose weight, including equipment and tools, is greater than 150 kg.
- To use an HT/ET harness or work station support belt with a load of between 100 kg and 150 kg (total weight of the user, equipment and tools) if any component in the fall-arrest system has a lower maximum load.
- To use an HT/ET harness if it has arrested a fall.
- To use an HT/ET harness or CE work station support belt outside the temperature range specified in this manual.
- To use an HT/ET harness if the vertical clearance is inadequate should the person fall.
- To use an HT/ET harness or CE work station support belt if you are not 100% fit.
- To use an HT/ET harness or CE work station support belt if you are a pregnant woman.
- To use an HT/ET harness or CE work station support belt if the safety function of one of the associated components is affected by the safety function of another element or interferes with it.
- To anchor an HT/ET harness or CE work station support belt through a fall-arrest system to a structural anchor where the resistance is less than 12 kN, or perceived as such.
- To carry out repair or maintenance operations on an HT/ET harness or CE work station support belt.
- To use an HT/ET harness or CE work station support belt if it is not complete, has been dismantled beforehand or if any components have been replaced.

6. Installation

Figure 3, page 5.

Assemble all adjustment loops of the harness when the operator is wearing it.

Adjust the lengths of the various straps: they should not be over or undertightened to obtain maximum comfort when using the system and for optimum fall-arrest protection. The harness will ensure efficient protection under these conditions.

- Whenever possible, the structural anchor point will be located at a height between 1.5 and 2 metres above the operator's feet. The structural anchor point must withstand a minimal resistance of 12 kN.
- The connection to the anchoring point or to the structure must be done using an EN 362 connector.
- For the connection of the fall-arrest system to the fall-arrest harness, refer to the instructions of the harness and the fall-arrest system in order to use the proper anchorage point and the proper attaching procedure.



Before and during use, it is necessary to plan out how possible rescue can be efficiently and safely conducted, within less than 15 minutes. Beyond this time, operator is in danger.

7. Components and materials

Figure 1, on page 3: Harness - EN 361 - EN 358 - EN 1497.

- PES shoulder strap.
 - PE Backplate.
 - Elastomer loop.
 - Steel adjustment buckle.
 - Steel side clip (fall-arrest point, see Figure 1, on page 3).
 - Steel or PES chest clip (fall-arrest point, see Figure 1, on page 3)
 - Steel back clip (fall-arrest point, see Figure 1, on page 3).
 - PES buttock strap.
 - PP chest buckle.
 - Marking label.
 - Marking "A", of the attachment points, on the D ring or the strap.
 - Steel side clip (handling point, see Figure 1, on page 3).
 - Backplate in PE foam and fabric.
 - Marking label.
 - POM service ring.
 - Steel adjustment buckle.
 - Elastomer loop.
 - Rescue strap.
 - Rescue lanyard label.
 - Attachment D-ring for rescue.
 - Central belt attachment.
- Strap + seam threads: polyester.
 - Loops made of galvanized steel and aluminum.
 - Cordura-covered foam back piece.
 - Back plate, loops: polyethylene, thermoplastic elastomer.

8. Permissible attachments

Fall-arrester system (EN 363):

- EN 795 Anchorage.
- An end connector (EN 362).
- A fall-arrest system (EN 353-1/2 - EN 355 - EN 360).
- A connector (EN 362).
- A fall-arrest harness (NF EN 361).

Before using an EN 363 fall-arrest system, check that every component is usable and in working order

9. Maintenance and storage

- If a harness becomes dirty, wash it in clean cold water, possibly with a detergent for delicate fabrics, using a synthetic-fiber brush.
- When the harness becomes wet, either during use or washing, leave it to dry naturally in the shade and away from all sources of heat.

See figure 5, on page 5.

- During stocking and transport, protect the equipment against any danger (cutting edge, direct heat source, chemical substances, UV, etc.).

10. Conformity of the equipment

Tractel SAS, RD 619 - Saint-Hilaire-sous-Romilly - F - 10102 Romilly-sur-Seine - France, hereby declares that the safety equipment described in this manual.

- complies with the requirements of Regulation (EU) 2016/425 of the European Parliament of March 2016.
- is identical to the PPE, having been subject to the "EU"-type-examination certificate issued by the APAVE SUDEUROPE SAS - CS 60193 - 13322 Marseille - France, identified under the number 0082, and tested in accordance with standards EN 361 dated 2002, EN 358 dated 2018.
- is subject to the procedure referred to in Annex VIII of Regulation (EU) 2016/425 of the European Parliament, module D, under the control of a notified body: APAVE SUDEUROPE SAS - CS 60193 - 13322 Marseille - France, identified under the number 0082.

11. Marking

The label on each of the HT/ET harnesses and CE belts indicates:

- a: The trade name: Tractel®.
- b: The name of the product,
- c: The reference standard followed by the year of application,
- d: The product reference,
- e: CE Logo followed by the number 0082, identification number of the approved body responsible for production control,
- f: Year and month of manufacture,
- g: The serial number,
- h: A pictogram showing that the manual must be read before use,
- w: Maximum operating load.

For the HT R harnesses, an additional label is provided near the anchorage D-ring for the rescue lanyard, comprising:

- i: The trademark,
- j: The reference standard followed by the year of application,
- k: A pictogram indicating that you must read the user manual before use, a text indicating: for rescue operations only.

12. Periodic inspections

An annual periodical inspection is required, but depending on the frequency of use, environmental conditions and regulations of the company or the country of use, periodical inspections may be more frequent.

Periodical inspections shall be carried out by an approved and competent technician and in accordance with the manufacturer's examination procedures as laid down in the file "Verification procedures for Tractel® PPE".

Verification of the legibility of the marking on the product is an integral part of the periodical inspection.

Following the periodical inspection, a certificate of return to service must be issued by the approved and competent technician who performed the periodical inspection. This return to service must be recorded on the inspection sheet in the middle of this manual. This inspection sheet should be retained throughout the life of the product until it is scrapped.

After arresting a fall, this textile product must be dismantled and destroyed, even if there is no visible alteration.

13. Life cycle

Tractel® textile PPE equipments as harnesses, lanyards, ropes and energy absorbers, Tractel® Mechanical PPE equipments as stopcable™ and stopfor™ fall arresters, blocfor™ self-retracting fall arresters, and the Tractel® lifelines can be used without restrictions from their manufacturing date providing that:

- A normal use is made in accordance with the instructions manual,
- A periodical inspection, which must be accomplished at least once a year by an approved and competent technician. At the end of this periodical inspection, the PPE must be certified fit to return to service, in writing,
- Instructions manual procedures for storage and transport are strictly met.
- As a general rule and so long as the conditions of use mentioned above are respected, their life cycle may be longer than 10 years.

14. Withdrawal from service

When disposing of the product, all components must be recycled with preliminary sorting of components into metallic and synthetic materials. These materials must be recycled by specialist bodies. During disposal, dismantling to separate components should be achieved by a duly trained person.



Manufacturer's name and address:
Tractel SAS - RD 619 - BP 38
Saint Hilaire sous Romilly
10102 Romilly sur Seine
France

Lined writing area with 20 horizontal lines.

feuille de contrôle - inspection sheet - kontrollkarte - controleblad - hoja de revisión - scheda di revisione - Folha de controle - Δελτίο ελέγχου - kontrollskjema - kontrollblad - tarkastuslista - kontrolnílist - kontrolnyy listok

Type de produit Type of product Produktbezeichnung Produkttype Tipo de produto Tipo de producto Τύπος προϊόντος Ποικιλία προϊόντος Ποικιλία τύπου Typ produktu Тип изделия	Référence produit Product reference Codenummer Produktcode Referencia producto Referenzprodukt Referencia do produto Κωδικός προϊόντος Ποικιλία προϊόντος Produktreferanse Jolliteen viitenumero Prilozheniya Oznaczenie produktu Номер изделия	Numéro de série Serial number Seriennummer Número de serie Número de serie Número do utilizador Όνομα του χρήστη Brukerens navn Användarens namn Serijski broj Nazivnik Број и назив Фамилія пользоваця		
Date de fabrication Date of manufacture Fertigstellungsdatum Fecha de fabricación Data di produzione Data de fabrico Ημερομηνία κατασκευής Fabricasjonsdato Valmistuspäivä Fabricationsdato Data produkції Дата виробництва	Date d'achat Date of purchase Aankoopdatum Fecha de compra Data di acquisto Data de compra Ημερομηνία αγοράς Προσφώνηση Päivämäärä Ostodat Data zakupu Дата покупки	Date de mise en service Date of first use Användningsdatum Datum ingebruikgenging Fecha de puesta en servicio Data di messa in servizio Data de entrada em serviço Ημερομηνία έναρξης λειτουργίας Första användningsdagen Käyttöönottopäivä Dato for ibrugtagning Data prizekazania do uzytku Дата вводу в експлуатацію		

**Vérification - Inspection - Prüfung - Controle - Verificaciones - Verifiche
Verificação - Έλεγχος - Kontroll - Kontroll - Tarkustus - Eftersyn - Kontrola - Проверка**

		Date Date Datum Datum Fecha Data Дата Ημερομηνία Datum Päivä Data Дата	Date de provision examens Date of inspection Prüfung Datum van het vaststellen van het probleem Data della prossima ispezione Data do teste de manutenção Seurakseen tarkastuksen päivämäärä Data nastupnega pregleda Дата составления отчета	Nom du contrôleur Name of inspector Name des Prüfers Naam van de controller Nome del controllore Nome do controlador Kontrollören navn Beskrivningsnamns namn Tarkastajien nimi Kontrolörens namn Nazwisko kontrolującego Өвчиний прогөөрлөгч	Visa Signatur Unterschrift Gezien Firma Firma Φάσμα Visa Stämpel Hyväksyntä Underskrift Pozwolenie Βίβα	Réparation - Repairing Reparatur - Herstellung - Reparación Riparazione - Reparação - Επιδιόρθωση Reparasjon - Reparation - Korjaus Reparation - Narrawa - Починка

Lined writing area with 20 horizontal lines.